

# VIRGIN BED

MAURO LIPPARINI



Letto dall'elegante forma scultorea, essenziale e accogliente, espressione della vocazione sartoriale di MisuraEmme, in grado di coniugare morbidezza e razionalità.

Profili architettonici esaltano i volumi imbottiti e conferiscono al contempo un leggero segno grafico. Disponibile con o senza cassone, in differenti dimensioni.

Si contraddistingue per la testata avvolgente, disponibile in tessuto, pelle o velluto.

TIPOLOGIA / LETTI

**MisuraEmme®**



## DESIGNER

MAURO LIPPARINI

**Mauro Lipparini** ha conseguito la Laurea in Architettura nel 1980 presso l'Università degli Studi di Firenze, della quale è stato professore. Lipparini ha vinto i concorsi internazionali di design Young & Designer Milano (1987) e International Du Pont Award Köln (Germania, 1988 e 1989). L'intensa attività di Lipparini nel campo del design industriale include il mobile per la casa e per l'ufficio, l'industria tessile e altri prodotti creati per numerose aziende in Europa e in Giappone. Nell'ambito dell'architettura e dell'interior design, Lipparini si è principalmente concentrato sull'abitazione privata e pubblica, sugli showroom e i locali di vendita al dettaglio, e sulle installazioni espositive. Inoltre Lipparini progetta e realizza avanzati sistemi di immagine di corporate identity, dalla grafica ai servizi editoriali, alla produzione. Lo stile di Lipparini, basato sulle forme essenziali e le linee chiare ed energiche caratteristiche del minimalismo naturale, è imbevuto d'uno spirito gioioso, di un esaltante senso di piacere estetico e della creatività. Nel suo libero impiego di colori, trame organiche, originali idee visive, Lipparini amplifica la tavolozza del minimalismo, incanalando l'immediatezza e la potenza di quest'estetica verso una nuova era di grande maturità e senso di benessere.



# FINITURE TESTATA/GIROLETTO

## INDIO



A31  
Madreperla

A36 Quarzo

A35 Pietra

A32  
Malachite

A30 Ematite

A33 Zaffiro

A34 Onice  
verde

A37 Basalto

## NODONE

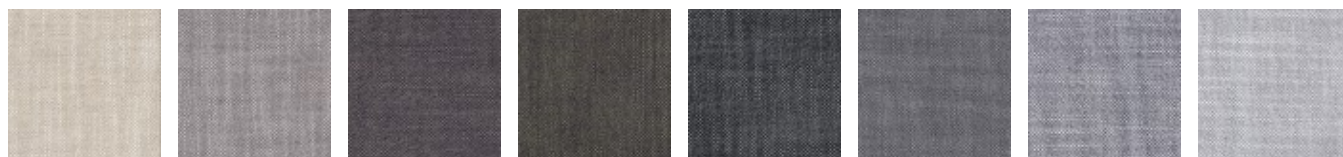

A41 Sabbia

A47 Argilla

A48  
Corteccia

A44 Muschio

A40 Carbone

A46 Roccia

A43 Ghiaia

A42 Sasso

## JOJO



B41 Cicogna

B46 Fungo

B48 Radice

B4A Ghianda

B49  
Scoiattolo

B47  
Marmotta

B44 Lichene

B43 Ghio

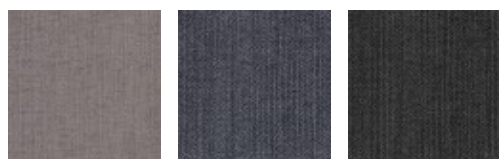

B45 Tortora

B42 Piccione

B40 Corvo

## 629

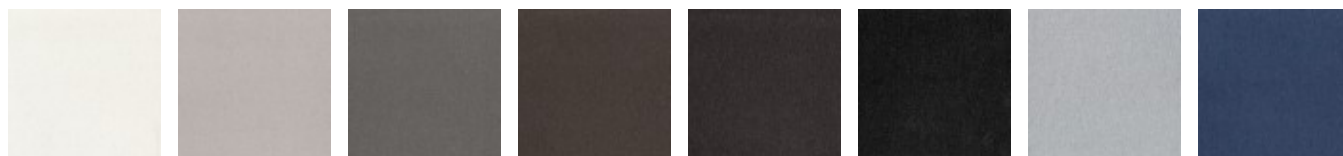

B61 White

B66 Beige

B69 Light  
brown

B67 Taupè

B65 Brown

B68 Dark  
brown

B62 Light  
gray

B63 Blue



B60 Black

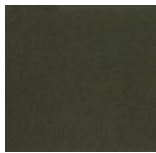

B64 Green

## BARBAT



B31 Cigno



B36 Tortora



B37  
Beccaccino



B34 Airone



B32 Ghiro



B33 Piccione



B35 Riccio

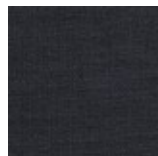

B30 Corvo

## TULSA



C82 Orso  
polare



C83 Airone



C85 Lepre

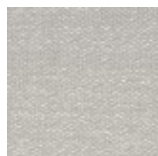

C88 Alpaca

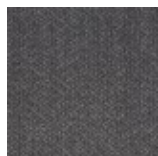

C86 Cervo

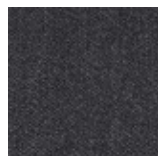

C81 Corvo

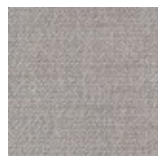

C87  
Alligatore

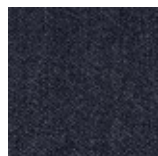

C84 Squalo  
blu

## M155



C91 Platino



C92 Argento



C90 Ferro



C93 Oro



C94 Bronzo

## FUNKY



C70 White  
mix



C71 Rock  
mix



C7A Nuts  
mix



C78 Green  
mix

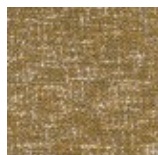

C76 Mustard  
mix



C77 Orange  
mix



C72 Brown  
mix



C79 Blue  
mix



C73 Iron mix



C74 Grey mix



C75 Black mix

## ARTIDE



C20 Ecrù

## BRERA



D31 Cigno



D36 Tortora

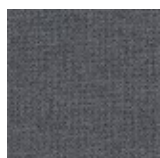

D37 Gufo

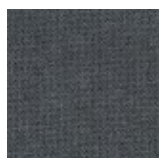

D34 Picchio verde



D32 Airone



D35 Piccione

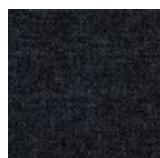

D33 Rondine

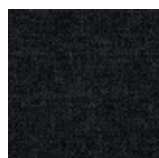

D30 Corvo

## INDIANSKOP



D1B Sabbia



D1G Creta



D1F Betulla



D1C Sasso



D1D Roccia

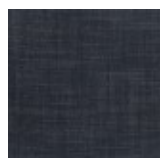

D1A Carbone



D1E Lichene

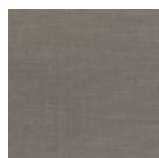

D1H Terra

## TUNDRA



D2B Cigno



D2F Tortora



D2G Fungo



D2H Cicogna

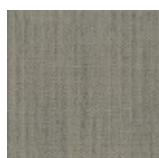

D2L Ghianda



D2J Cervo



D2E Lichene



D2C Ghiro



D2D Lupo

D2K Talpa

D2A Corvo

## FLYNN



D3B Rugiada

D3F Pietra

D3G Roccia

D3L Civetta

D3J Gufo

D3K Daino

D3E Muschio

D3H Guscio di lumaca



D3C Nebbia

D3D Pioggia

D3A Notte

## GONG

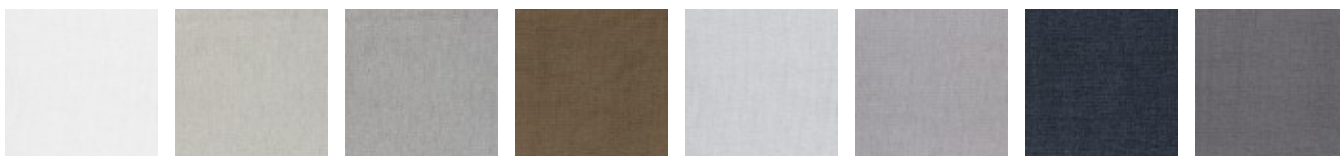

E61 Cigno

E67 Creta

E6C Lumaca

E68 Scoiattolo

E62 Airone

E65 Tortora

E6A Blu fiume

E6B Talpa

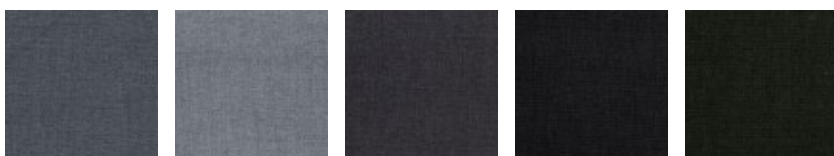

E66 Riccio

E63 Passero

E69 Orso bruno

E60 Rondine

E64 Felce

## TADAO

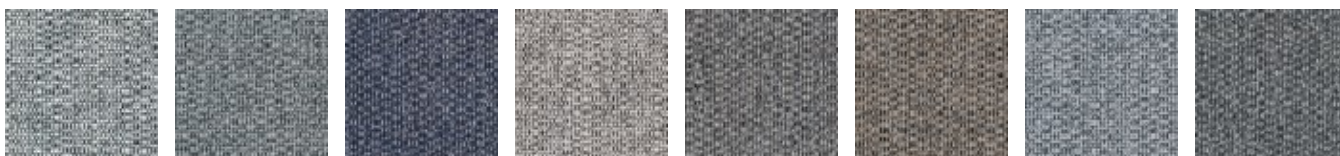

E81 White mix

E85 Sand mix

E83 Zaffiro mix

E86 Snow mix

E88 Bronze mix

E87 Cappuccino mix

E82 Stone mix

E80 Taupè mix



E89 Rust mix

E84 Green mix

E90 Sulfur mix

## YELLOWSTONE

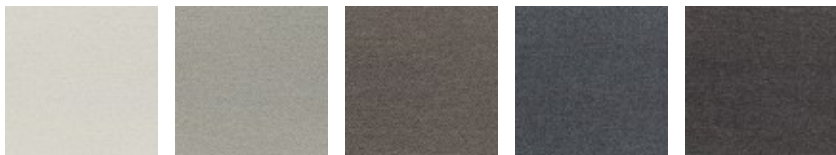

E96 Rugiada

E99 Sabbia

E98 Terra

E95 Pietra

E97  
Corteccia

## GEMMA PLUS

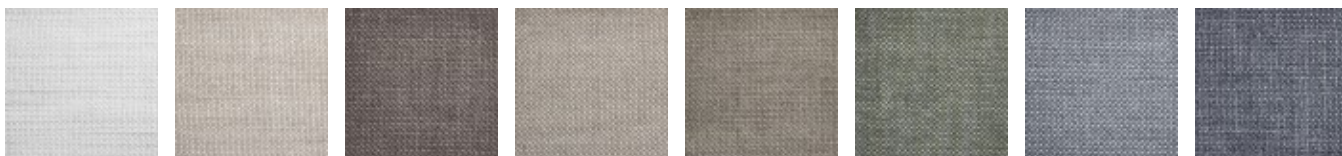

D54 Cigno

D59 Fungo

D61  
Castagna

D65 Lumaca

D60  
Nocciola

D57 Sotto  
bosco

D55 Ghiro

D56 Gufo

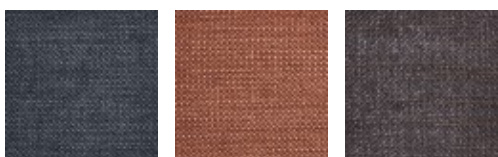

D73 Rondine

D66 Volpe

D58 Riccio

## VELLUTO LARIO

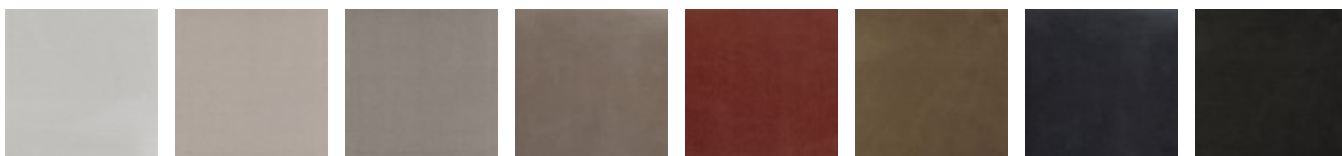

F33 Pietra

F56 Sabbia

F57 Tortora

F51  
Scoiattolo

F54 Volpe

F55 Cervo

F35 Rondine

F53  
Corteccia

## VELLUTO REGAL

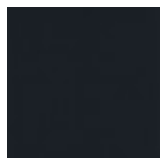

F58 Mirtillo

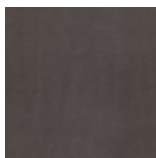

F5A  
Castagna

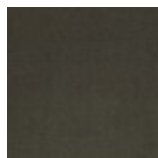

F59 Muschio

## LUXUS



E50 Bianco



F01 Ecrù



F02 Grigio  
perla

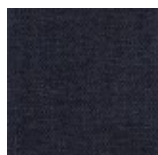

F05 Blu

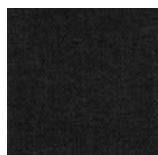

F03 Lava

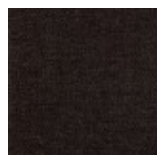

F04 Testa di  
moro

## GAUCHO



F28 Neve



F21 Nebbia

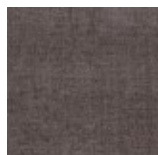

F29  
Grandine



F20  
Tempesta di  
sabbia



F25 Solstizio

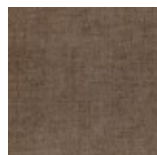

F26  
Tramonto

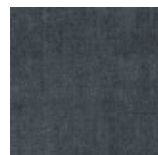

F24 Acque  
tropicali

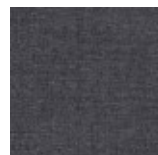

F23 Nube

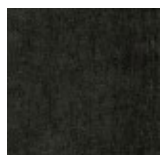

F27 Foresta



F22 Tornado

## ORSETTO



H1B Perla

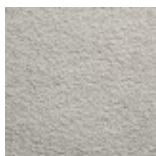

H1G  
Conchiglia



H1H  
Alabastro



H1C Opale

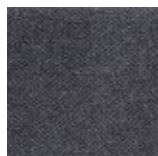

H1F Ematite

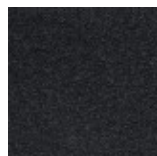

H1A Onice  
nero

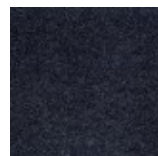

H1D Zaffiro

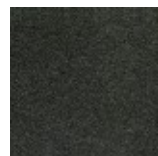

H1E Giada

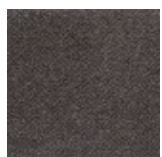

H1J Agata

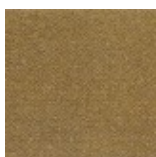

H1L Topazio

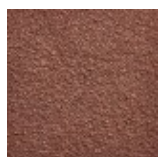

H1K Ambra



## ECOPELLI LAVORATE A291

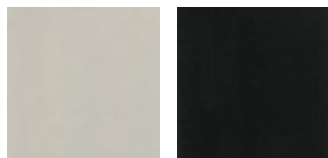

CL1 Sabbia

CL6 Nero

## ECOPELLI LAVORATE A844



CL8 Sepia

## ECOPELLI LAVORATE REBEL

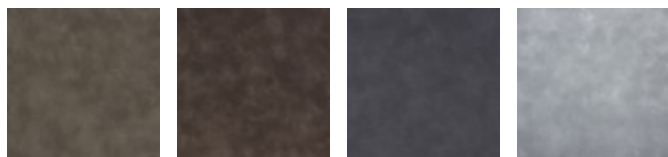

CM3 Argilla

CM5  
Tabacco

CM7 Grigio  
scuro

CM9 Grigio  
chiaro

## ECOPELLI LAVORATE VINTAGE

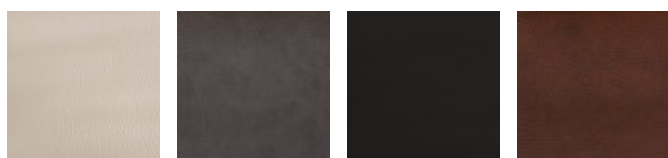

CM6 Creta

CM4  
Cappuccino

CM8 Coffee

CM2  
Mattone

## ECOPELLI LISCE BLOOM



CF7 Nuvola

CD3 Beige

CF8  
Nocciola

CF6 Argilla

CD1 Testa di  
Moro

CF9 Caffè

## ECOPELLI LISCE OLD

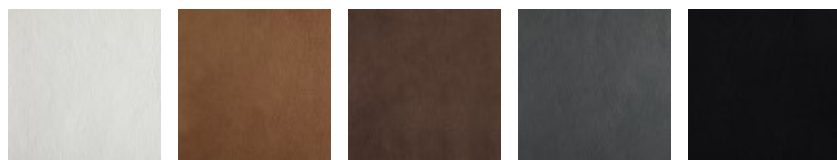

CD6 Bianco    CD9 Cuoio naturale    CD8 Mattone    CD7 Grigio scuro    CD0 Nero

## PELLI LISCE



H38 Sabbia    H36 Camoscio    H3F Muschio    H71 Testa di Moro    H3E Grigio Caldo    H35 Grigio Chiaro    H08 Asfalto    H26 Antracite

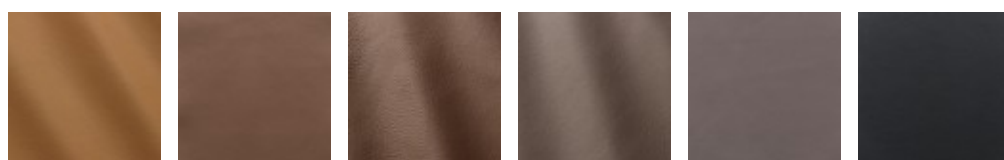

H3B Cuoio    H31 Naturale    H3A Terracotta    H34 Fango    H32 Taupè    H73 Nero

## PELLI SCAMOSCIATE

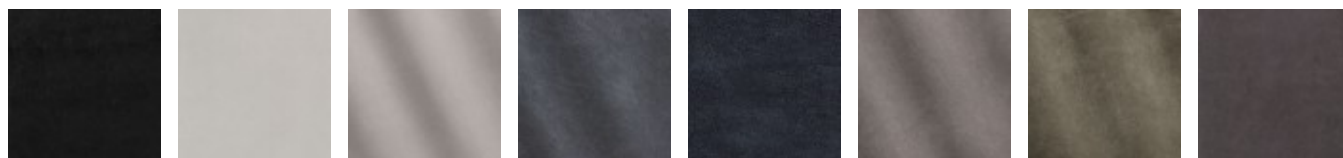

HAE Panther    HA6 Orso polare    HAF Volpe artica    HAC Lupo grigio    HA3 Squalo blu    HA7 Elefante    HA8 Alligatore    HA5 Falco

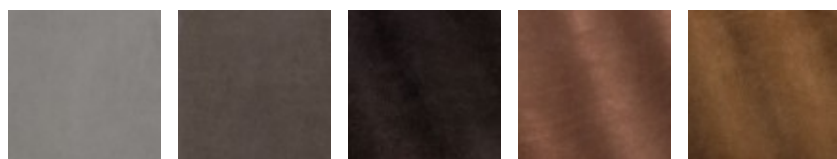

HA1 Leone    HA9 Antilope    HAA Grizzly    HAB Orango    HAD Tigre

## PELLI NABUCCATE

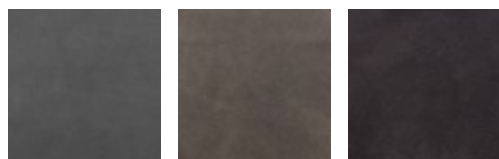

HN3 Leone    HN2 Rinoceronte    HN1 Orso bruno

## NABUK

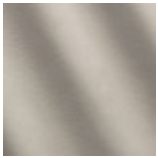

N08 Orso  
polare

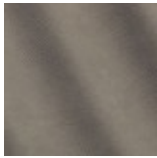

N05  
Rinoceronte

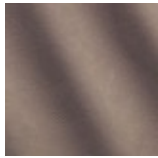

N14  
Antilope

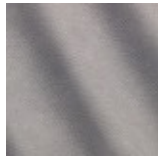

N11 Lupo

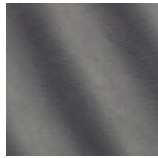

N12 Balena

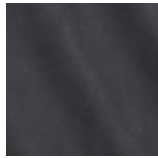

N09 Squalo  
blu

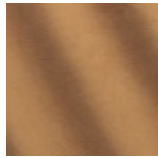

N10 Tigre



N07 Leone



N04  
Alligatore



N06 Volpe



N13 Orso  
bruno

# DIMENSIONI

Letto rete fissa (materasso L. 1600 x P. 2000 mm)

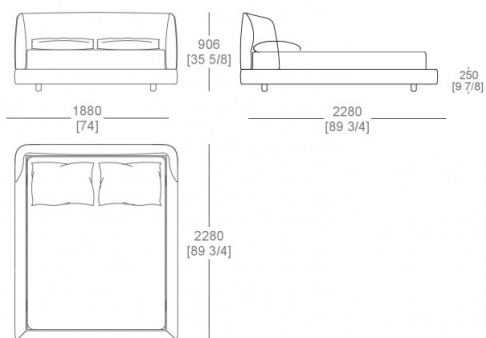

Letto rete fissa (materasso L. 1600 x P. 2100 mm)

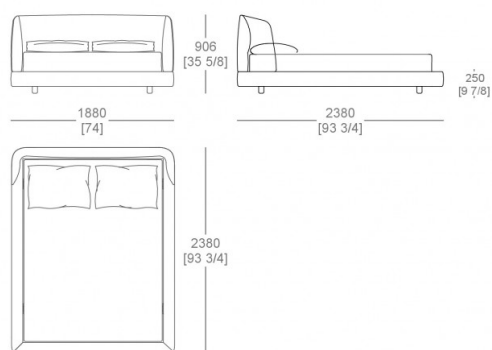

Letto rete fissa (materasso L. 1800 x P. 2000 mm)

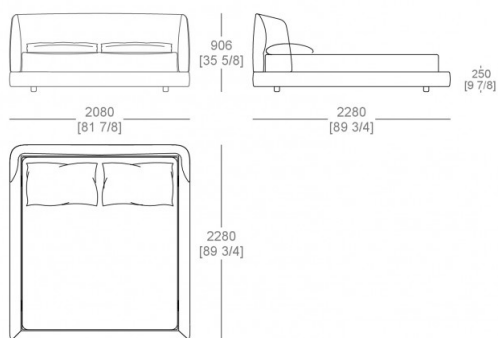

Letto rete fissa (materasso L. 1800 x P. 2100 mm)

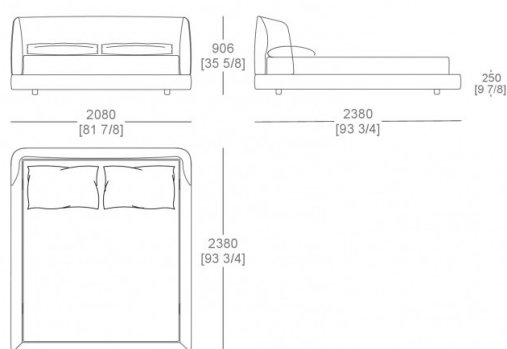

Letto rete alzabile (materasso L. 1600 x P. 2000 mm)

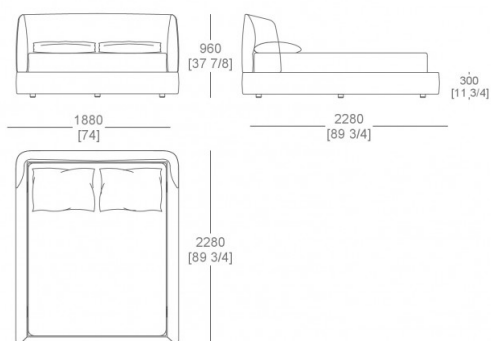

Letto rete alzabile (materasso L. 1800 x P. 2000 mm)

